

(*) To be opened in case of DHW enabled for the related HHP

- This schematic is for example only and does not replace design by a qualified technician;
- The final schematic must be prepared respecting all the laws, norms and decrees in force, in order to facilitate a correct installation in compliance with the rule of the art;
- For the proper functioning of all system components, follow the instructions in the design, installation and user manuals provided by the manufacturer;
- This outline may be amended by the Ariston Group at any time without prior notice.

SCHEME Hydraulic		
DATE 19.10.2023.	REV.	PAGE 1 / 3

SCHEME NAME
EN_021-5xPMC4.PK_HCD-CD1_BUF.4_1D



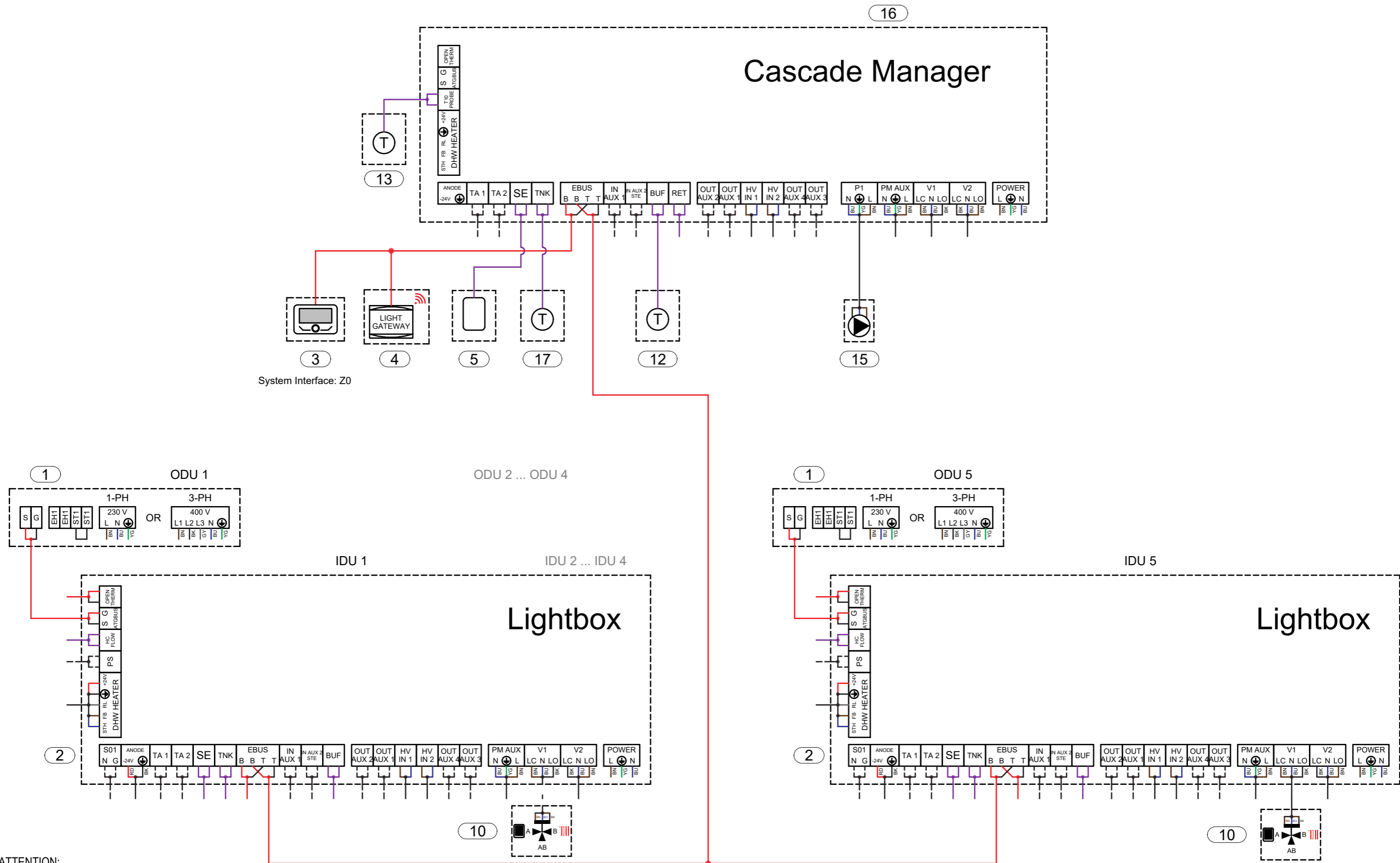

ATTENTION:
 The power supplies of each indoor and outdoor unit must be connected separately to dedicated residual-current circuit breakers as indicated in the installer manuals

- This schematic is for example only and does not replace design by a qualified technician;
- The final schematic must be prepared respecting all the laws, norms and decrees in force, in order to facilitate a correct installation in compliance with the rule of the art;
- For the proper functioning of all system components, follow the instructions in the design, installation and user manuals provided by the manufacturer;
- This outline may be amended by the Ariston Group at any time without prior notice.

ALREADY INCLUDED
OR
OPTIONAL

















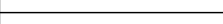

ALREADY INCLUDED
OR
OPTIONAL

SCHEME Electrical		
DATE 19.10.2023.	REV.	PAGE 2 / 3

SCHEME NAME EN_021-5xPMC4.PK_HCD-CD1_BUF.4_1D
--

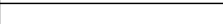

Pos.	Description
1	EXTERNAL UNIT HHP - MONOBLOC 1-PH OR 3-PH
2	LIGHTBOX
3	SYSTEM INTERFACE
4	LIGHT GATEWAY
5	EXTERNAL PROBE
6	KIT ANTI-FREEZE
7	DHW TANK HHP 1-COIL WITH T PROBE
8	DHW INLET SAFETY GROUP
9	HE KIT BELOW ODU
10	HEATING-DHW 3-WAY VALVE
11	THERMOSTATIC MIXING VALVE
12	BUFFER TANK 4 ATTACKS WITH T PROBE
13	T PROBE
14	EXPANSION VESSEL - HEATING
15	CIRCULATOR PWM
16	HHP CASCADE MANAGER
17	DHW TANK HHP 1-COIL WITH T PROBE

Legend	
Hydraulic	
	Hot water
	Cold water
	DHW hot water
	DHW cold water
	DHW mixed water
	DHW recirculation water
	Refrigerant fluid
	Gas connection
	Electric connection
Electric	
	BN Brown (L1)
	BU Blue (N)
	YG yellow green (PE)
	BK black (L2)
	GY Grey (L3)
	RD red
	Dry contact
	BUS connection
	Generic signal
	Sensor signal

- This schematic is for example only and does not replace design by a qualified technician;
- The final schematic must be prepared respecting all the laws, norms and decrees in force, in order to facilitate a correct installation in compliance with the rule of the art;
- For the proper functioning of all system components, follow the instructions in the design, installation and user manuals provided by the manufacturer;
- This outline may be amended by the Ariston Group at any time without prior notice.

SCHEME Legend		
DATE 19.10.2023.	REV.	PAGE 3 / 3

SCHEME NAME
EN_021-5xPMC4.PK_HCD-CD1_BUF.4_1D