

Pos.	Description
	EXPANSION VESSEL - DHW
	MOTORIZED 3-WAY VALVE
1	EXTERNAL UNIT HHP - SPLIT 1-PH OR 3-PH
2	IDU SPLIT WITH 3 WAY VALVE
3	SYSTEM INTERFACE
4	LIGHT GATEWAY
5	EXTERNAL PROBE
6	BUFFER TANK 4 ATTACKS WITH T PROBE
7	CIRCULATOR PWM
7	UNDER FLOOR HEATING
8	CIRCULATOR PWM
10	HE KIT BELOW ODU
10	FANCOIL COOLING
11	KIT SHUT-OFF VALVES
12	HEATING-COOLING 3-WAY VALVE

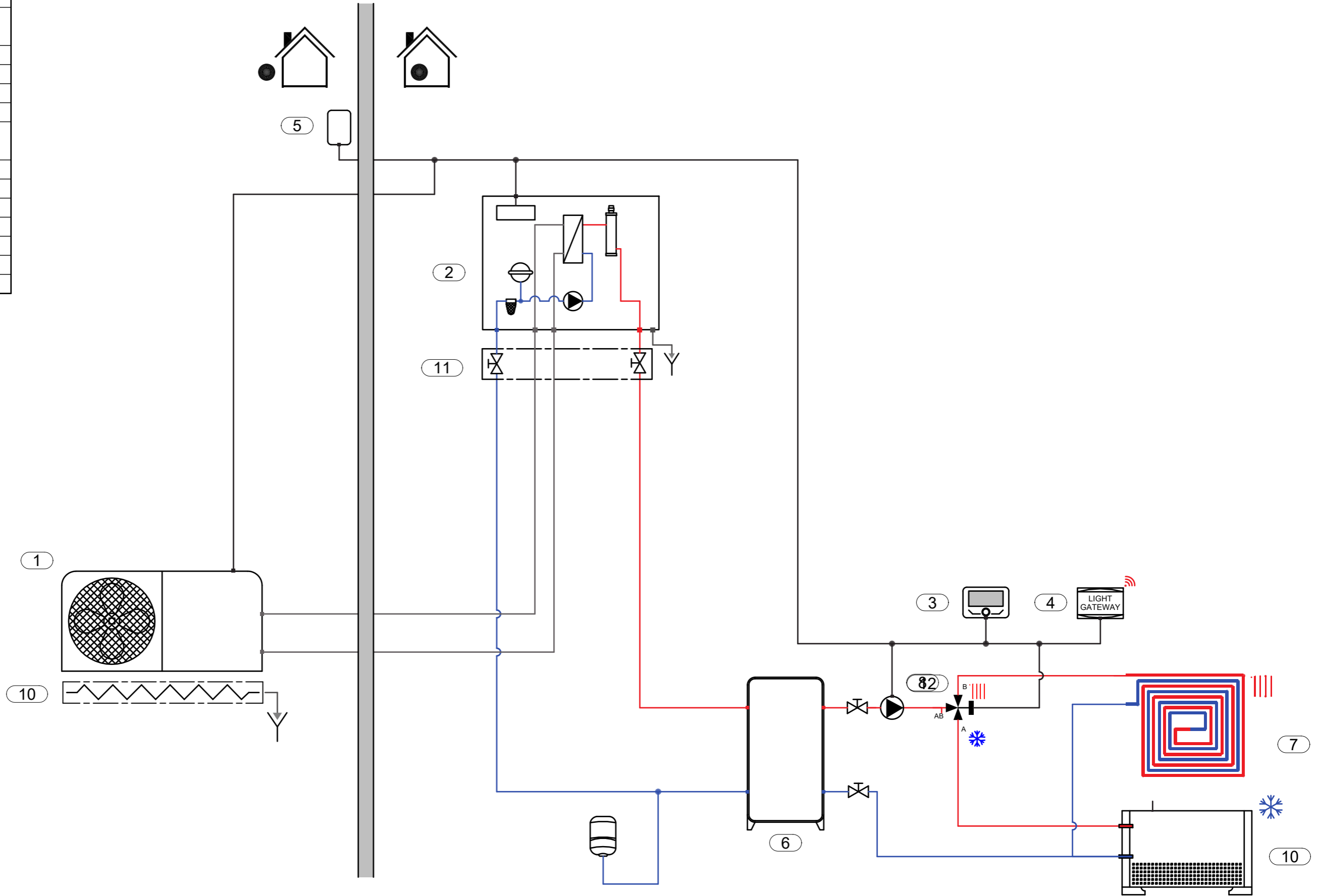

- This schematic has to be considered as example of the system functionality only and does not replace design by a qualified technician;
- The final schematic must be prepared respecting all the laws, norms and decrees in force, in order to facilitate a correct installation in compliance with the rule of the art;
- For the proper functioning of all system components, follow the instructions in the design, installation and user manuals provided by the manufacturer;
- This outline may be amended by the Ariston Group at any time without prior notice.

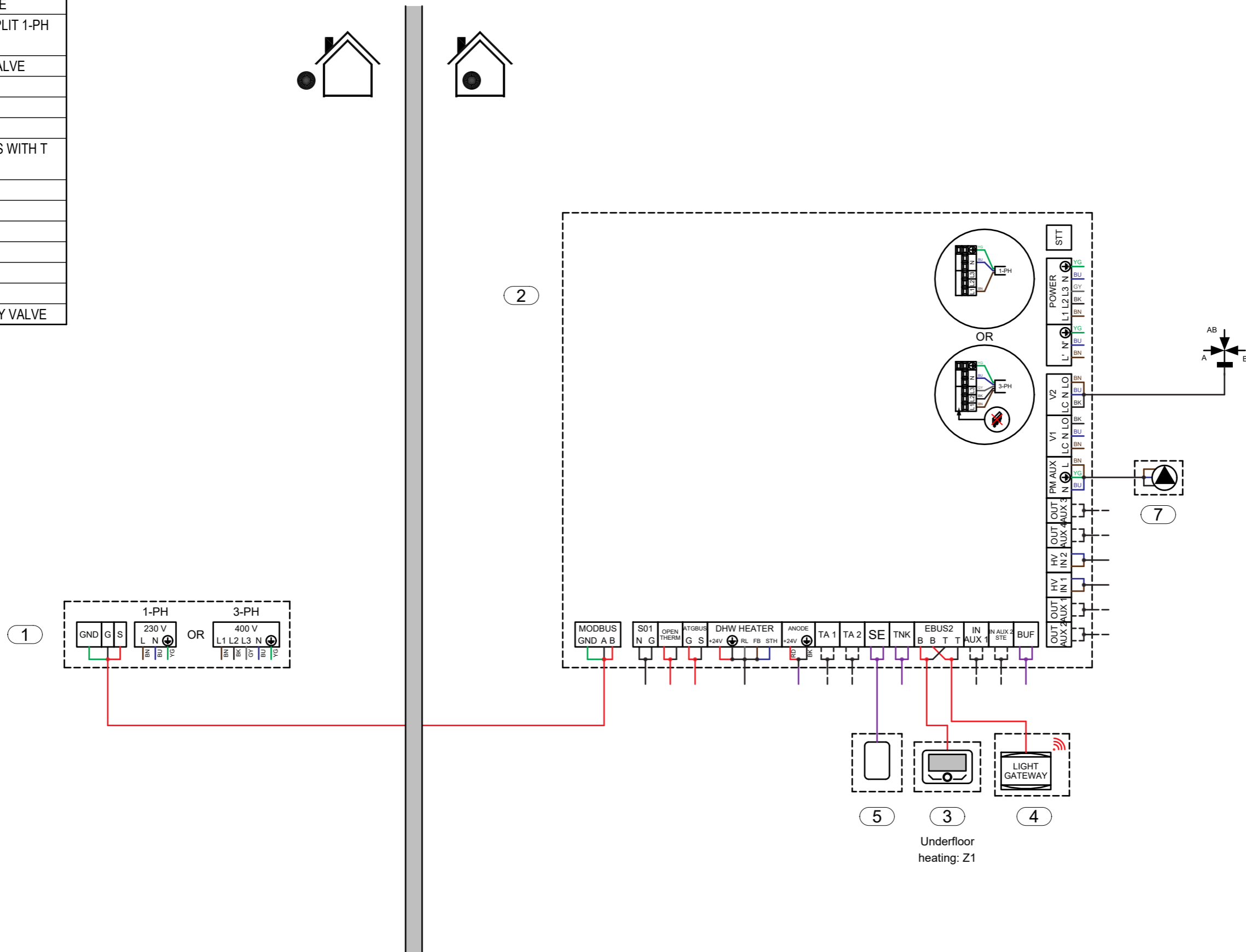















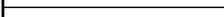

Pos.	Description
	EXPANSION VESSEL - DHW
	MOTORIZED 3-WAY VALVE
1	EXTERNAL UNIT HHP - SPLIT 1-PH OR 3-PH
2	IDU SPLIT WITH 3 WAY VALVE
3	SYSTEM INTERFACE
4	LIGHT GATEWAY
5	EXTERNAL PROBE
6	BUFFER TANK 4 ATTACKS WITH T PROBE
7	CIRCULATOR PWM
7	UNDER FLOOR HEATING
8	CIRCULATOR PWM
10	HE KIT BELOW ODU
10	FANCOIL COOLING
11	KIT SHUT-OFF VALVES
12	HEATING-COOLING 3-WAY VALVE



- This schematic has to be considered as example of the system functionality only and does not replace design by a qualified technician;
- The final schematic must be prepared respecting all the laws, norms and decrees in force, in order to facilitate a correct installation in compliance with the rule of the art;
- For the proper functioning of all system components, follow the instructions in the design, installation and user manuals provided by the manufacturer;
- This outline may be amended by the Ariston Group at any time without prior notice.

SCHEME Electrical		
DATE 18.12.2023.	REV.	PAGE 2 / 3

SCHEME NAME
EN_013_PCM4.PL.S_HCD_CD1_BUF.4_1D

Legend	
Hydraulic	
	Hot water
	Cold water
	DHW hot water
	DHW cold water
	DHW mixed water
	DHW recirculaiton water
	Refrigerant fluid
	Gas connection
	Electric connection
Electric	
	BN Brown (L1)
	BU Blue (N)
	YG yellow green (PE)
	BK black (L2)
	GY Grey (L3)
	RD red
	Dry contact
	BUS connection
	Generic signal
	Sensor signal

- This schematic has to be considered as example of the system functionality only and does not replace design by a qualified technician;
- The final schematic must be prepared respecting all the laws, norms and decrees in force, in order to facilitate a correct installation in compliance with the rule of the art;
- For the proper functioning of all system components, follow the instructions in the design, installation and user manuals provided by the manufacturer;
- This outline may be amended by the Ariston Group at any time without prior notice.

SCHEME			SCHEME NAME
Legend			EN_013_PCM4.PL.S_HCD_CD1_BUF.4_1D
DATE	REV.	PAGE	
18.12.2023.		3 / 3	