

Pos.	Description
	EXPANSION VESSEL - DHW
1	EXTERNAL UNIT HHP - MONOBLOC 1 -PH OR 3-PH
2	IDU MONO WITH 3 WAY VALVE
3	SYSTEM INTERFACE
4	LIGHT GATEWAY
5	EXTERNAL PROBE
6	KIT ANTI-FREEZE
7	UNDER FLOOR HEATING
8	DHW INLET SAFETY GROUP
9	HE KIT BELOW ODU
10	FANCOIL COOLING
11	KIT SHUT-OFF VALVES
12	HEATING-COOLING 3-WAY VALVE
13	DHW TANK HHP 1-COIL WITH T PROBE AND ANODE
14	BUFFER TANK 4 ATTACKS
15	THERMOSTATIC MIXING VALVE
15	BY-PASS VALVE

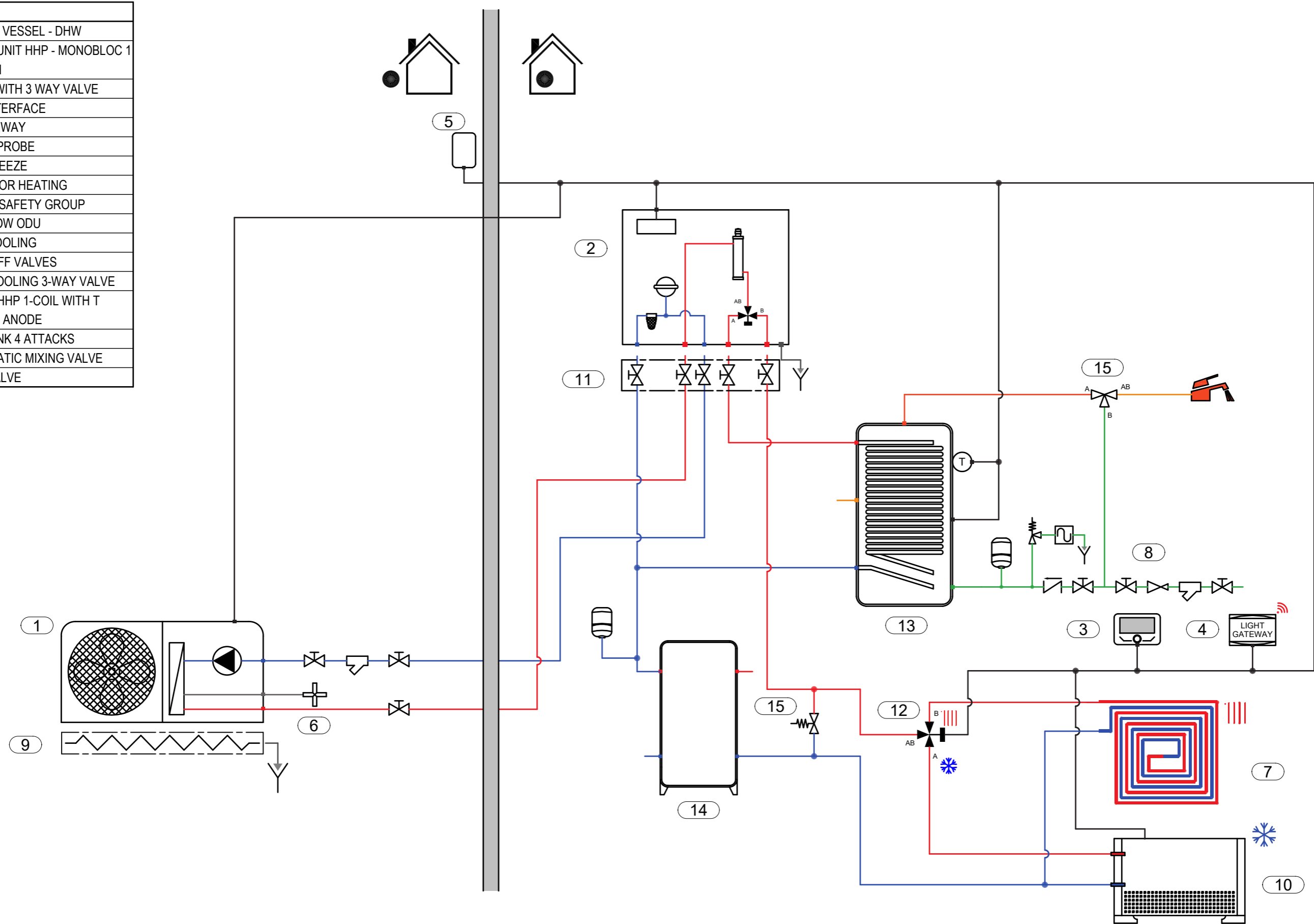

- This schematic is for example only and does not replace design by a qualified technician;
- The final schematic must be prepared respecting all the laws, norms and decrees in force, in order to facilitate a correct installation in compliance with the rule of the art;
- For the proper functioning of all system components, follow the instructions in the design, installation and user manuals provided by the manufacturer;
- This outline may be amended by the Ariston Group at any time without prior notice.

SCHEME Hydraulic		
DATE 19.10.2023.	REV.	PAGE 1/3

SCHEME NAME
EN_017_PCM4.PL.M_HCD_CD1_BUF.2_1D



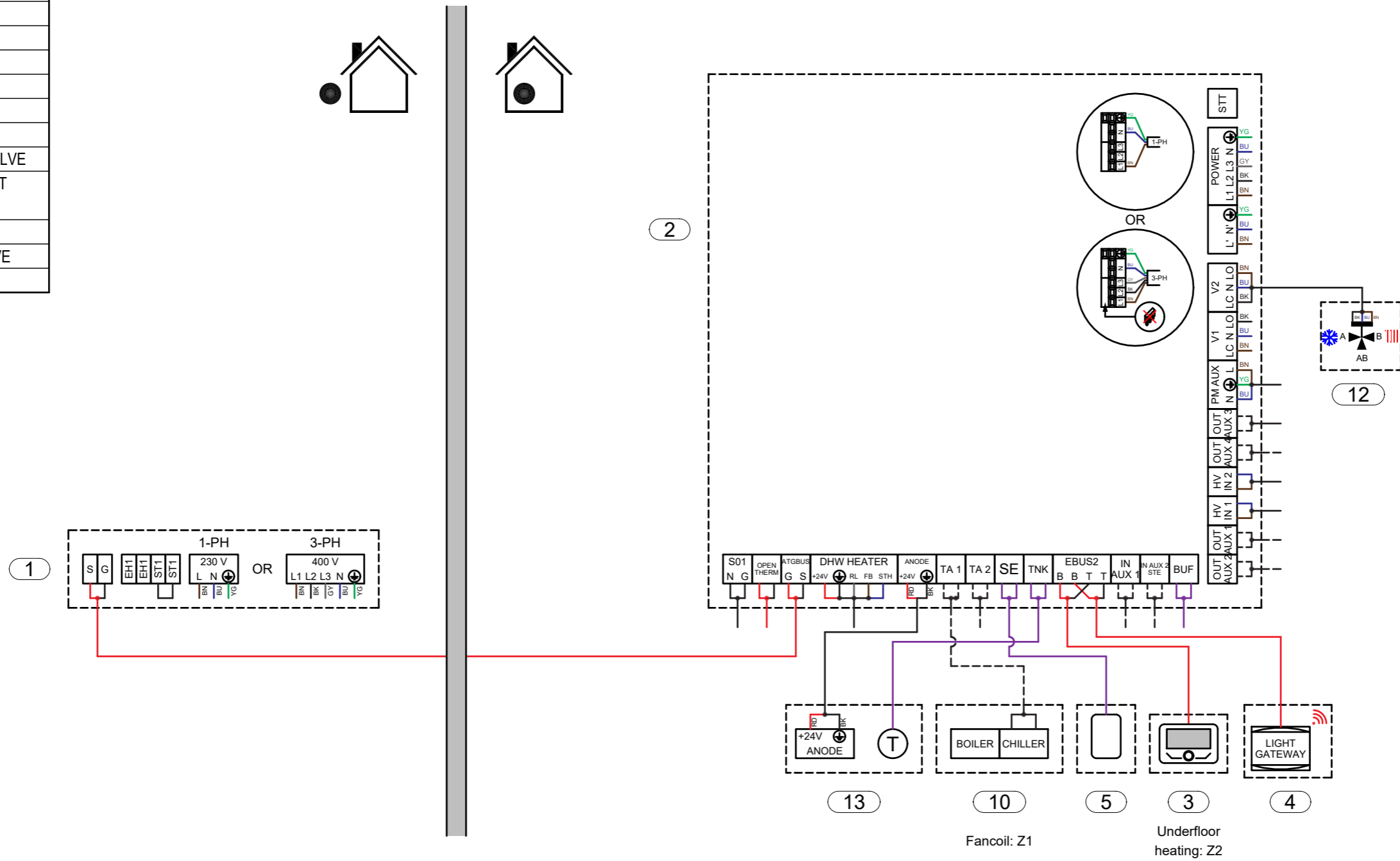











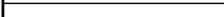
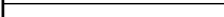

Pos.	Description
	EXPANSION VESSEL - DHW
1	EXTERNAL UNIT HHP - MONOBLOC 1-PH OR 3-PH
2	IDU MONO WITH 3 WAY VALVE
3	SYSTEM INTERFACE
4	LIGHT GATEWAY
5	EXTERNAL PROBE
6	KIT ANTI-FREEZE
7	UNDER FLOOR HEATING
8	DHW INLET SAFETY GROUP
9	HE KIT BELOW ODU
10	FANCOIL COOLING
11	KIT SHUT-OFF VALVES
12	HEATING-COOLING 3-WAY VALVE
13	DHW TANK HHP 1-COIL WITH T PROBE AND ANODE
14	BUFFER TANK 4 ATTACKS
15	THERMOSTATIC MIXING VALVE
15	BY-PASS VALVE



- This schematic is for example only and does not replace design by a qualified technician;
- The final schematic must be prepared respecting all the laws, norms and decrees in force, in order to facilitate a correct installation in compliance with the rule of the art;
- For the proper functioning of all system components, follow the instructions in the design, installation and user manuals provided by the manufacturer;
- This outline may be amended by the Ariston Group at any time without prior notice.

SCHEME		
Electrical		
DATE	REV.	PAGE
19.10.2023.		2 / 3

SCHEME NAME
EN_017_PCM4.PL.M_HCD_CD1_BUF.2_1D

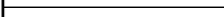
Legend	
Hydraulic	
	Hot water
	Cold water
	DHW hot water
	DHW cold water
	DHW mixed water
	DHW recirculaiton water
	Refrigerant fluid
	Gas connection
	Electric connection
Electric	
	BN Brown (L1)
	BU Blue (N)
	YG yellow green (PE)
	BK black (L2)
	GY Grey (L3)
	RD red
	Dry contact
	BUS connection
	Generic signal
	Sensor signal

- This schematic is for example only and does not replace design by a qualified technician;
- The final schematic must be prepared respecting all the laws, norms and decrees in force, in order to facilitate a correct installation in compliance with the rule of the art;
- For the proper functioning of all system components, follow the instructions in the design, installation and user manuals provided by the manufacturer;
- This outline may be amended by the Ariston Group at any time without prior notice.

SCHEME			SCHEME NAME
Legend			EN_017_PCM4.PL.M_HCD_CD1_BUF.2_1D
DATE	REV.	PAGE	
19.10.2023.		3 / 3	