

Pos.	Description
	KIT ZONE MANAGER H-C
	WIRED ROOM THERMOSTAT
	MGM III H
	MGM II H
	MOTORIZED 3-WAY VALVE
	CIRCULATOR GENERIC
	EXPANSION VESSEL - DHW
1	EXTERNAL UNIT HHP - MONOBLOC 1 -PH OR 3-PH
2	IDU MONO WITH 3 WAY VALVE
2	IDU FS MONO
3	SYSTEM INTERFACE
4	LIGHT GATEWAY
5	EXTERNAL PROBE
6	KIT ANTI-FREEZE
7	BUFFER TANK 4 ATTACKS WITH T PROBE
11	HE KIT BELOW ODU
12	KIT SHUT-OFF VALVES
12	UNDER FLOOR HEATING-COOLING
13	FANCOIL HEATING-COOLING
14	BY-PASS VALVE

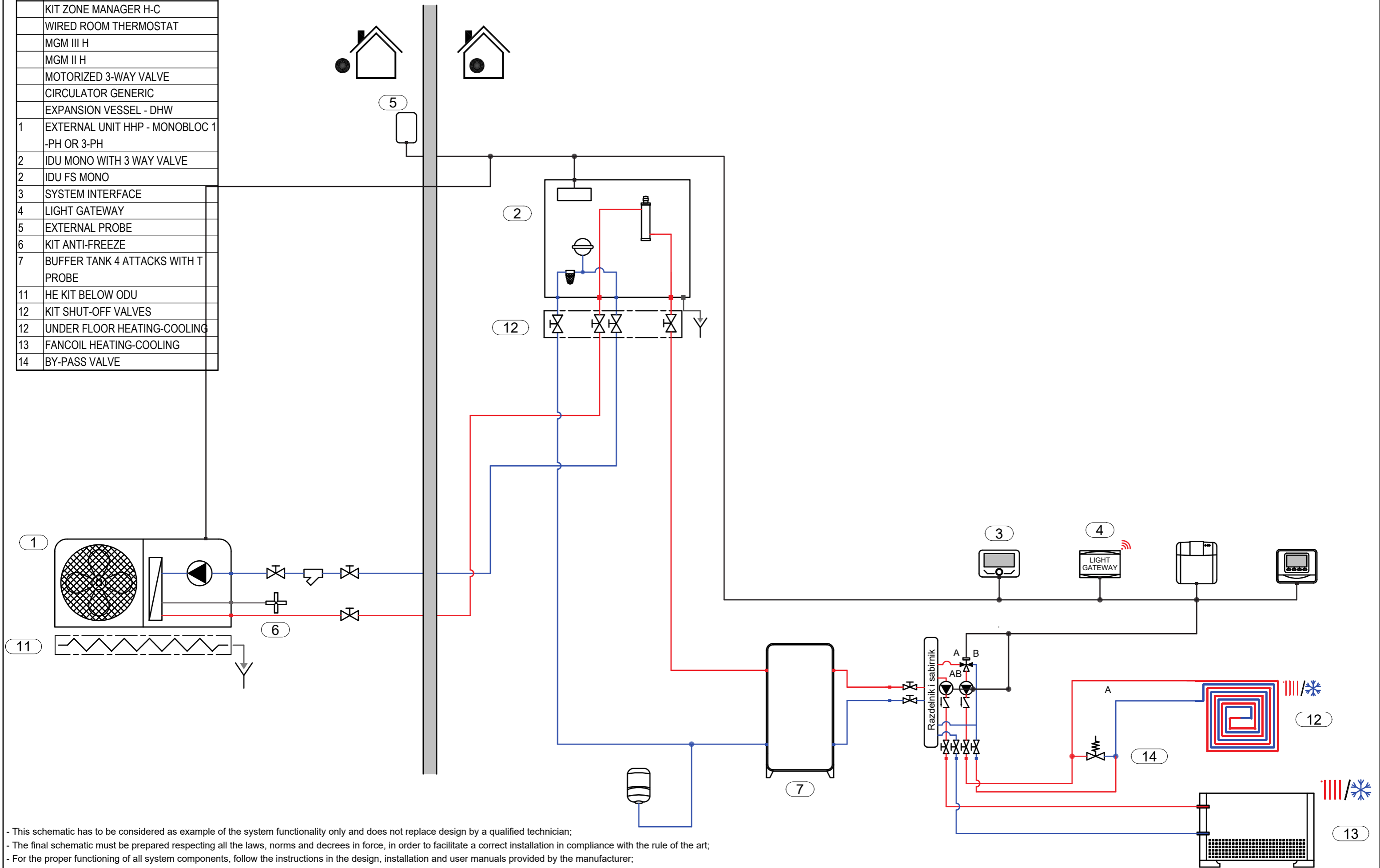

- This schematic has to be considered as example of the system functionality only and does not replace design by a qualified technician;
- The final schematic must be prepared respecting all the laws, norms and decrees in force, in order to facilitate a correct installation in compliance with the rule of the art;
- For the proper functioning of all system components, follow the instructions in the design, installation and user manuals provided by the manufacturer;
- This outline may be amended by the Ariston Group at any time without prior notice.

SCHEME		
Hydraulic		
DATE	REV.	PAGE
10.1.2024.		1 / 3

SCHEME NAME
EN_012_PCM4.PL.M_HCD_CD1_BUF.4_1D

Pos.	Description
	KIT ZONE MANAGER H-C
	WIRED ROOM THERMOSTAT
	MGM III H
	MGM II H
	MOTORIZED 3-WAY VALVE
	CIRCULATOR GENERIC
	EXPANSION VESSEL - DHW
1	EXTERNAL UNIT HHP - MONOBLOC 1 -PH OR 3-PH
2	IDU MONO WITH 3 WAY VALVE
2	IDU FS MONO
3	SYSTEM INTERFACE
4	LIGHT GATEWAY
5	EXTERNAL PROBE
6	KIT ANTI-FREEZE
7	BUFFER TANK 4 ATTACKS WITH T PROBE
11	HE KIT BELOW ODU
12	KIT SHUT-OFF VALVES
12	UNDER FLOOR HEATING-COOLING
13	FANCOIL HEATING-COOLING
14	BY-PASS VALVE

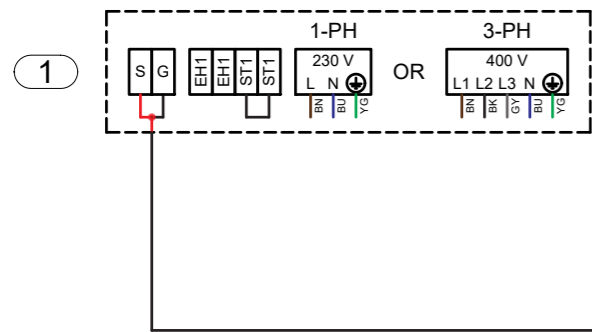
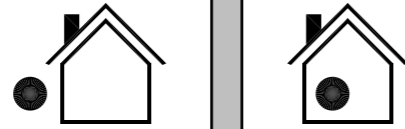

2

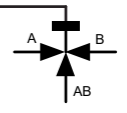
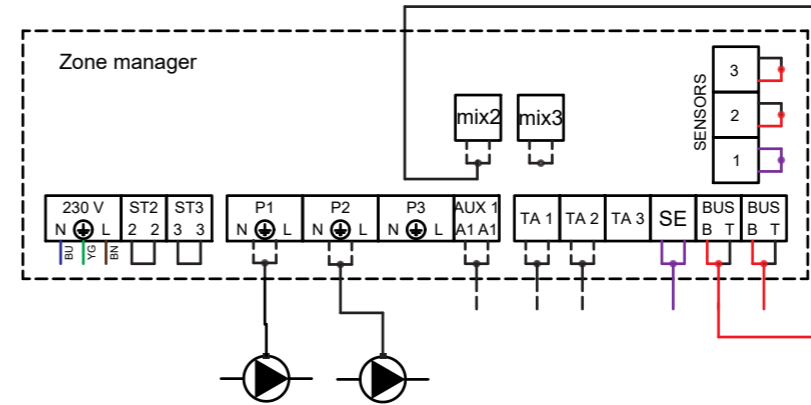
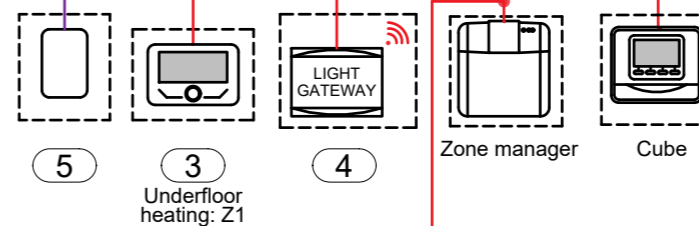
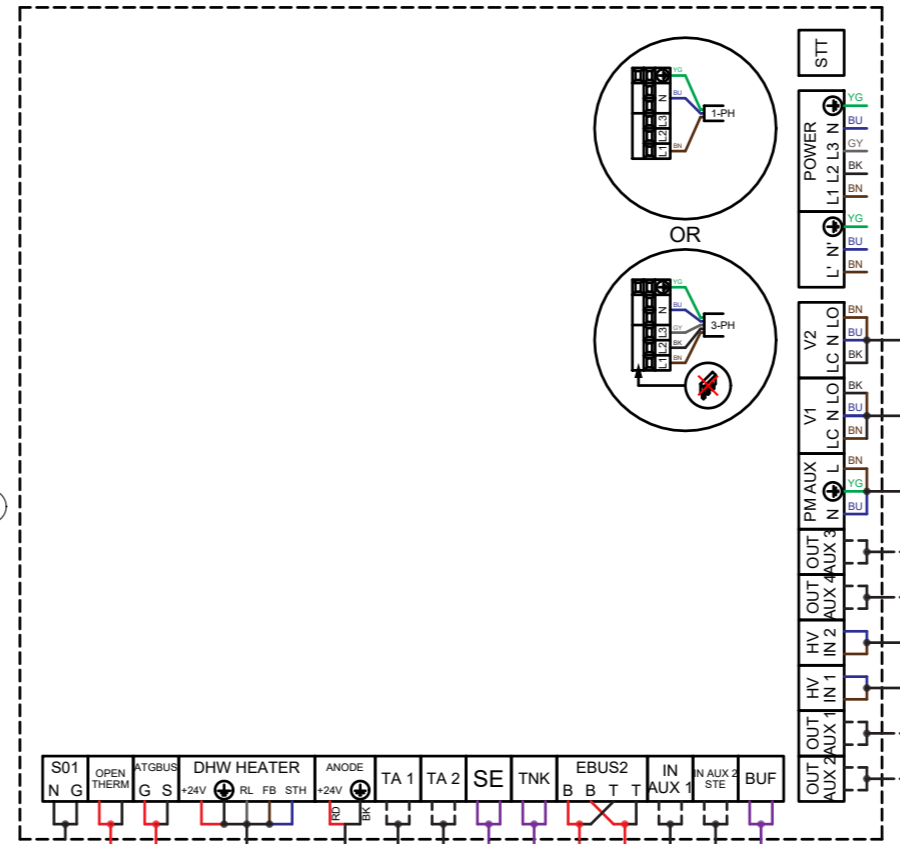















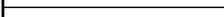



- This schematic has to be considered as example of the system functionality only and does not replace design by a qualified technician;
- The final schematic must be prepared respecting all the laws, norms and decrees in force, in order to facilitate a correct installation in compliance with the rule of the art;
- For the proper functioning of all system components, follow the instructions in the design, installation and user manuals provided by the manufacturer;
- This outline may be amended by the Ariston Group at any time without prior notice.

SCHEME		
Electrical		
DATE	REV.	PAGE
10.1.2024.		2 / 3

SCHEME NAME
EN_012_PCM4.PL.M_HCD_CD1_BUF.4_1D



Legend	
Hydraulic	
	Hot water
	Cold water
	DHW hot water
	DHW cold water
	DHW mixed water
	DHW recirculaiton water
	Refrigerant fluid
	Gas connection
	Electric connection
Electric	
	BN Brown (L1)
	BU Blue (N)
	YG yellow green (PE)
	BK black (L2)
	GY Grey (L3)
	RD red
	Dry contact
	BUS connection
	Generic signal
	Sensor signal

- This schematic has to be considered as example of the system functionality only and does not replace design by a qualified technician;
- The final schematic must be prepared respecting all the laws, norms and decrees in force, in order to facilitate a correct installation in compliance with the rule of the art;
- For the proper functioning of all system components, follow the instructions in the design, installation and user manuals provided by the manufacturer;
- This outline may be amended by the Ariston Group at any time without prior notice.

SCHEME Legend		
DATE 10.1.2024.	REV.	PAGE 3 / 3

SCHEME NAME EN_012_PCM4.PL.M_HCD_CD1_BUF.4_1D
--