

Pos.	Description
	EXPANSION VESSEL - DHW
	MOTORIZED 3-WAY VALVE
1	EXTERNAL UNIT HHP - MONOBLOC 1 -PH OR 3-PH
2	IDU MONO WITH 3 WAY VALVE
3	SYSTEM INTERFACE
4	LIGHT GATEWAY
5	EXTERNAL PROBE
6	KIT ANTI-FREEZE
7	BUFFER TANK 4 ATTACKS WITH T PROBE
7	UNDER FLOOR HEATING
8	CIRCULATOR PWM
10	FANCOIL COOLING
11	HE KIT BELOW ODU
12	KIT SHUT-OFF VALVES
12	HEATING-COOLING 3-WAY VALVE

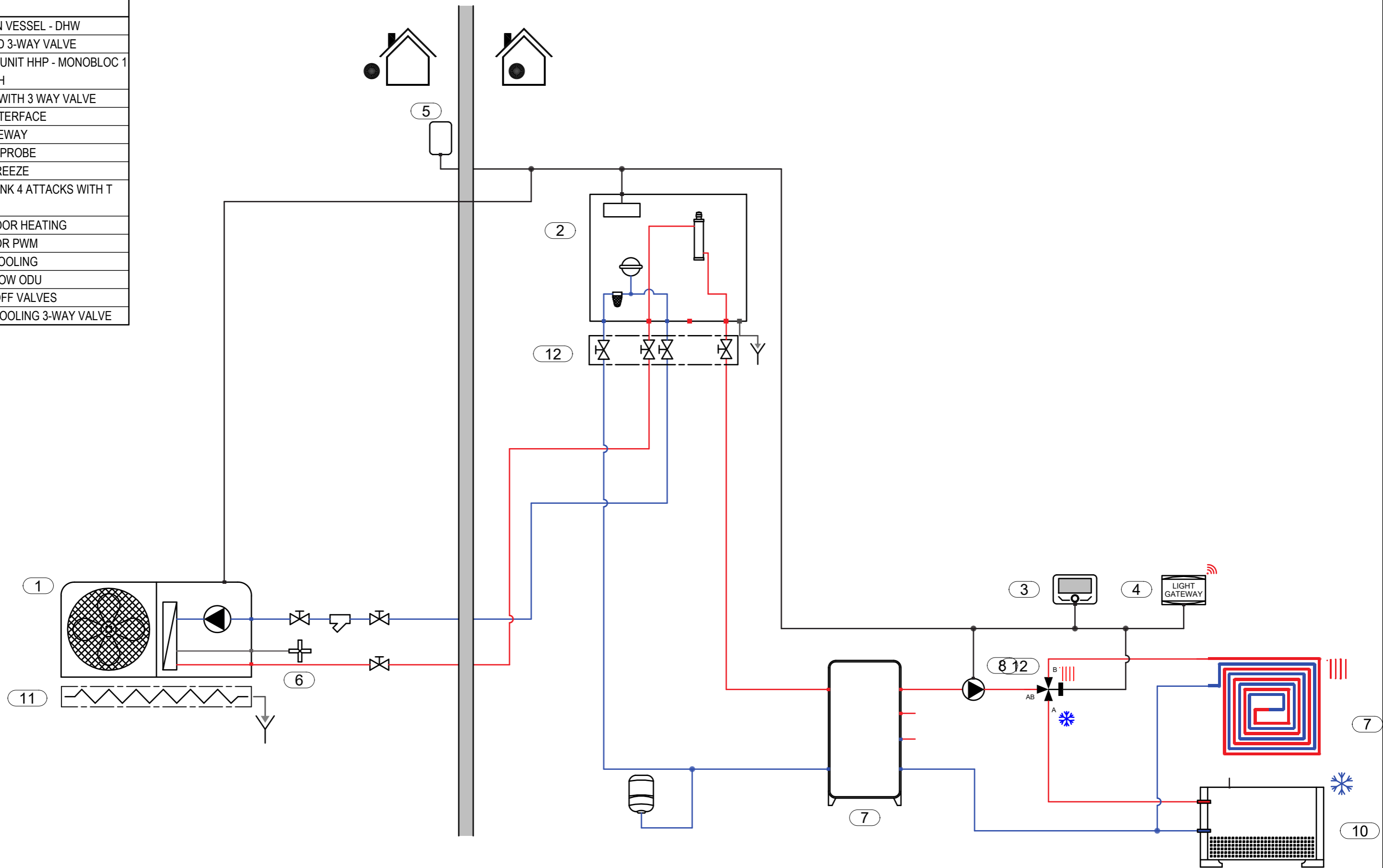

- This schematic is for example only and does not replace design by a qualified technician;
- The final schematic must be prepared respecting all the laws, norms and decrees in force, in order to facilitate a correct installation in compliance with the rule of the art;
- For the proper functioning of all system components, follow the instructions in the design, installation and user manuals provided by the manufacturer;
- This outline may be amended by the Ariston Group at any time without prior notice.

SCHEME		
Hydraulic		
DATE	REV.	PAGE
24.9.2023.		1/3

SCHEME NAME  
EN\_012\_PCM4.PL.M\_HCD\_CD1\_BUF.4\_1D



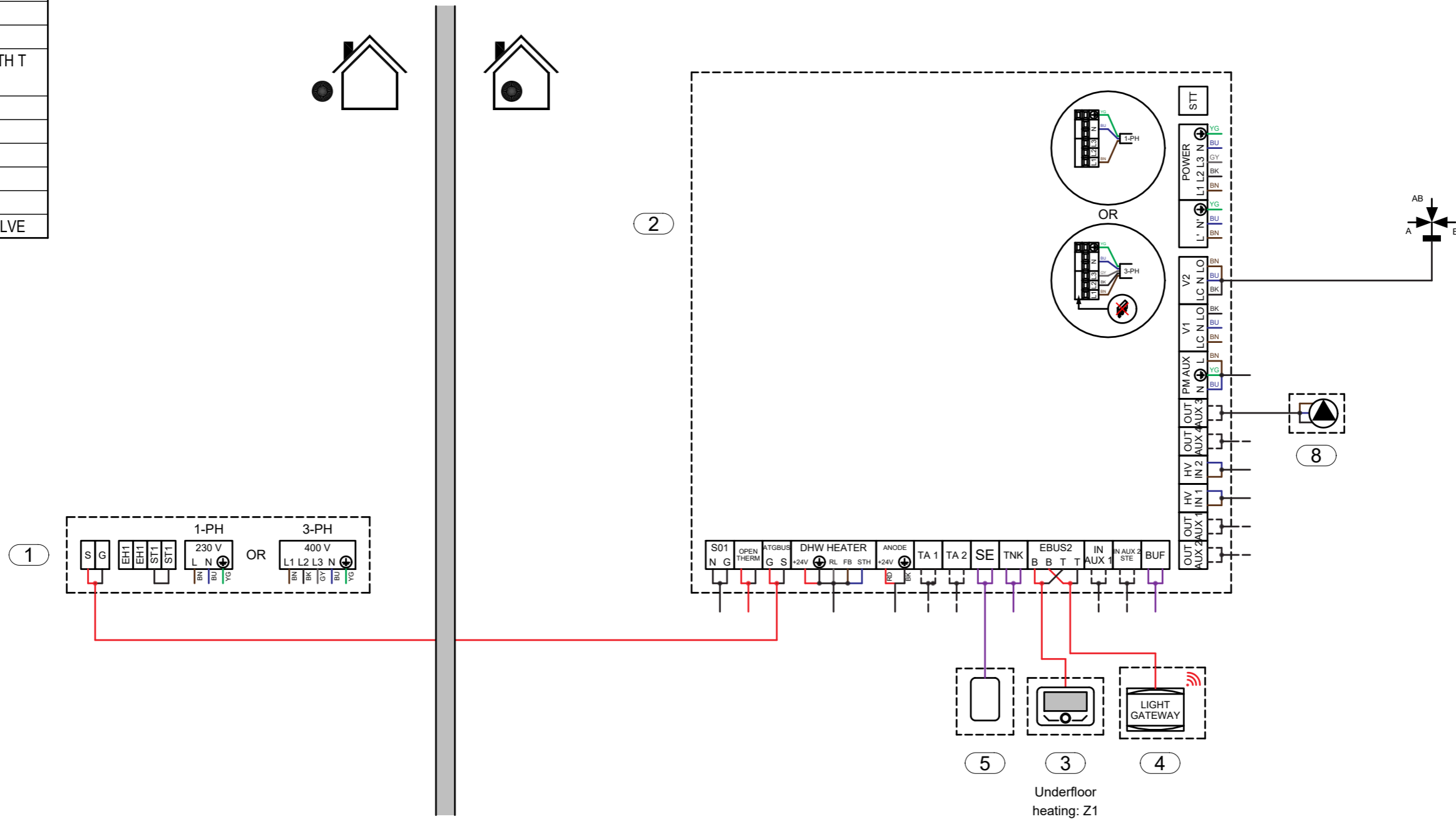













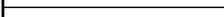

Pos.	Description
	EXPANSION VESSEL - DHW
	MOTORIZED 3-WAY VALVE
1	EXTERNAL UNIT HHP - MONOBLOC 1-PH OR 3-PH
2	IDU MONO WITH 3 WAY VALVE
3	SYSTEM INTERFACE
4	LIGHT GATEWAY
5	EXTERNAL PROBE
6	KIT ANTI-FREEZE
7	BUFFER TANK 4 ATTACKS WITH T PROBE
7	UNDER FLOOR HEATING
8	CIRCULATOR PWM
10	FANCOIL COOLING
11	HE KIT BELOW ODU
12	KIT SHUT-OFF VALVES
12	HEATING-COOLING 3-WAY VALVE



- This schematic is for example only and does not replace design by a qualified technician;
- The final schematic must be prepared respecting all the laws, norms and decrees in force, in order to facilitate a correct installation in compliance with the rule of the art;
- For the proper functioning of all system components, follow the instructions in the design, installation and user manuals provided by the manufacturer;
- This outline may be amended by the Ariston Group at any time without prior notice.

SCHEME Electrical		
DATE 24.9.2023.	REV.	PAGE 2 / 3

SCHEME NAME  
EN\_012\_PCM4.PL.M\_HCD\_CD1\_BUF.4\_1D

<b>Legend</b>	
<b>Hydraulic</b>	
	Hot water
	Cold water
	DHW hot water
	DHW cold water
	DHW mixed water
	DHW recirculaiton water
	Refrigerant fluid
	Gas connection
	Electric connection
<b>Electric</b>	
	BN Brown (L1)
	BU Blue (N)
	YG yellow green (PE)
	BK black (L2)
	GY Grey (L3)
	RD red
	Dry contact
	BUS connection
	Generic signal
	Sensor signal

- This schematic is for example only and does not replace design by a qualified technician;
- The final schematic must be prepared respecting all the laws, norms and decrees in force, in order to facilitate a correct installation in compliance with the rule of the art;
- For the proper functioning of all system components, follow the instructions in the design, installation and user manuals provided by the manufacturer;
- This outline may be amended by the Ariston Group at any time without prior notice.

SCHEME Legend		
DATE 24.9.2023.	REV.	PAGE 3 / 3

SCHEME NAME <b>EN_012_PCM4.PL.M_HCD_CD1_BUF.4_1D</b>
---

