

Pos.	Description
	KIT ZONE MANAGER H-C
	WIRED ROOM THERMOSTAT
	MGM III H
	EXPANSION VESSEL - DHW
	MGM II H
	MOTORIZED 3-WAY VALVE
	HEATING-DHW 3-WAY VALVE
	CIRCULATOR GENERIC
1	EXTERNAL UNIT HHP - SPLIT 1-PH OR 3-PH
2	IDU FS SPLIT
2	IDU FS MONO
3	SYSTEM INTERFACE
4	LIGHT GATEWAY
5	EXTERNAL PROBE
7	BUFFER TANK 4 ATTACKS WITH T PROBE
10	HE KIT BELOW ODU
10	DHW INLET SAFETY GROUP
12	THERMOSTATIC MIXING VALVE
12	UNDER FLOOR HEATING-COOLING
13	FANCOIL HEATING-COOLING
14	BY-PASS VALVE

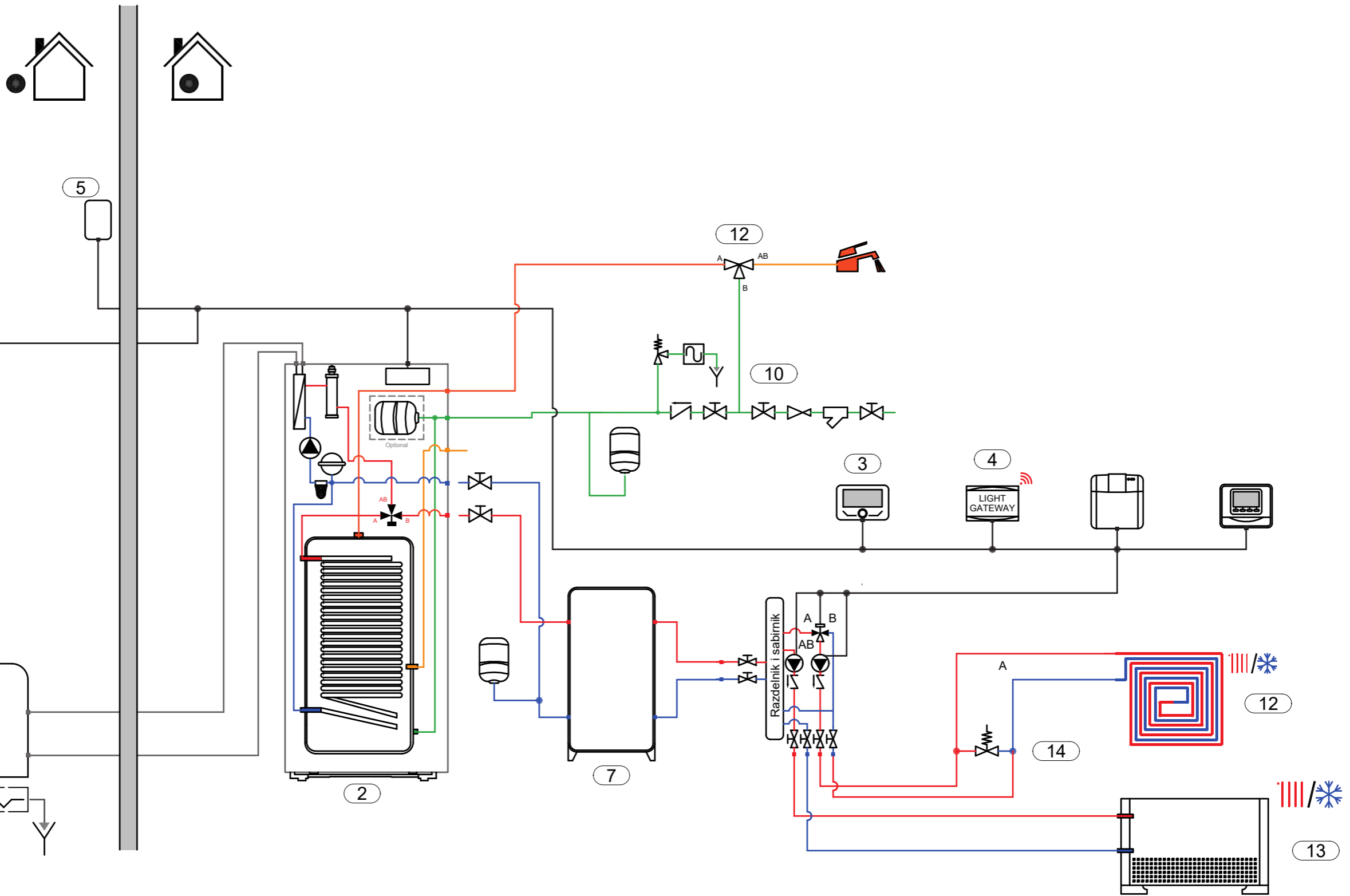

- This schematic is for example only and does not replace design by a qualified technician;
- The final schematic must be prepared respecting all the laws, norms and decrees in force, in order to facilitate a correct installation in compliance with the rule of the art;
- For the proper functioning of all system components, follow the instructions in the design, installation and user manuals provided by the manufacturer;
- This outline may be amended by the Ariston Group at any time without prior notice.

SCHEME		
Hydraulic		
DATE	REV.	PAGE
19.10.2023.		1 / 3

SCHEME NAME
EN_011-PCM4.CO.S_HCD-I_BUF.4_1D

Pos.	Description
	KIT ZONE MANAGER H-C
	WIRED ROOM THERMOSTAT
	MGM III H
	EXPANSION VESSEL - DHW
	MGM II H
	MOTORIZED 3-WAY VALVE
	HEATING-DHW 3-WAY VALVE
	CIRCULATOR GENERIC
1	EXTERNAL UNIT HHP - SPLIT 1-PH OR 3-PH
2	IDU FS SPLIT
2	IDU FS MONO
3	SYSTEM INTERFACE
4	LIGHT GATEWAY
5	EXTERNAL PROBE
7	BUFFER TANK 4 ATTACKS WITH T PROBE
10	HE KIT BELOW ODU
10	DHW INLET SAFETY GROUP
12	THERMOSTATIC MIXING VALVE
12	UNDER FLOOR HEATING-COOLING
13	FANCOIL HEATING-COOLING
14	BY-PASS VALVE

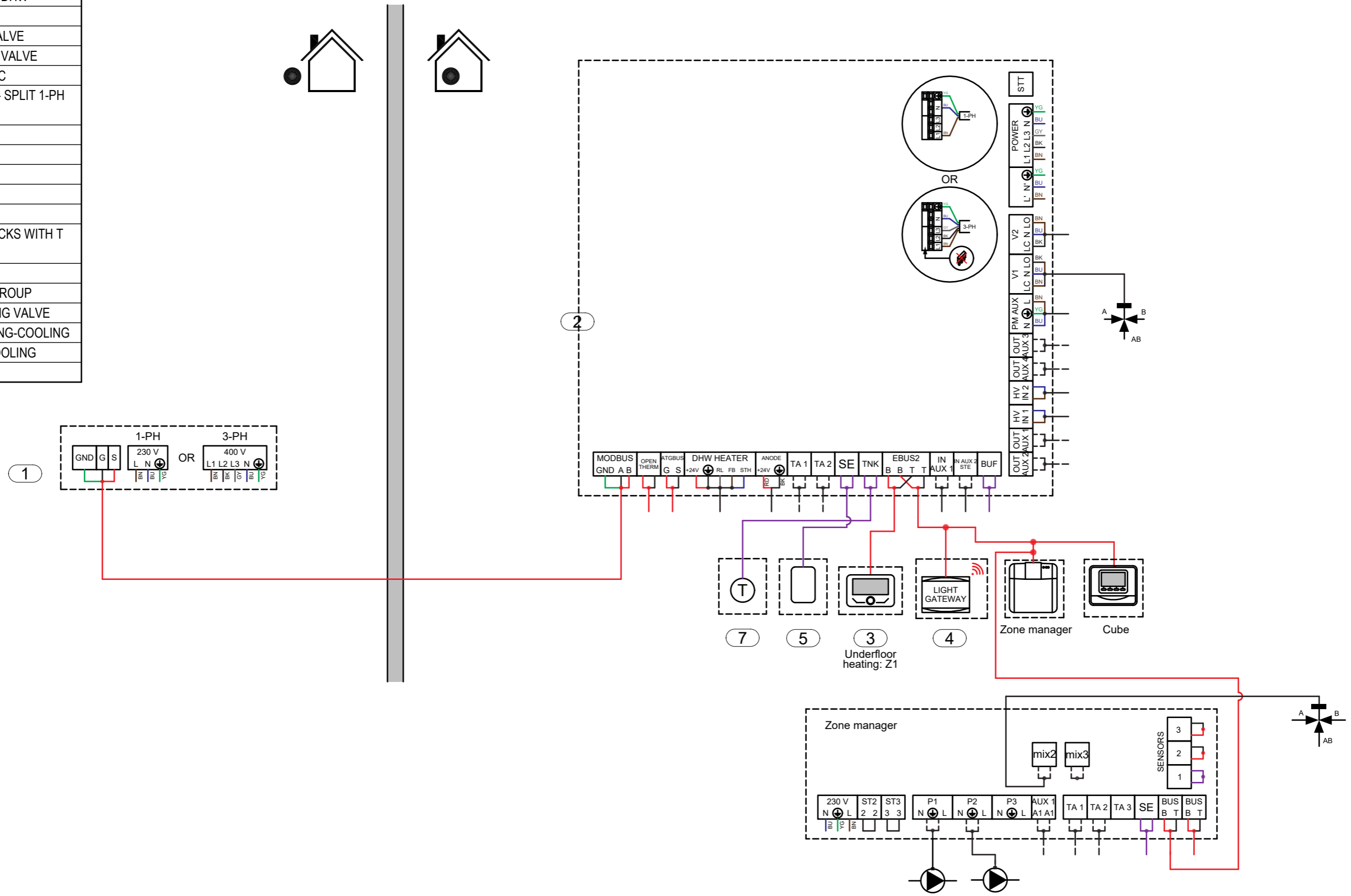















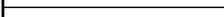



- This schematic is for example only and does not replace design by a qualified technician;
- The final schematic must be prepared respecting all the laws, norms and decrees in force, in order to facilitate a correct installation in compliance with the rule of the art;
- For the proper functioning of all system components, follow the instructions in the design, installation and user manuals provided by the manufacturer;
- This outline may be amended by the Ariston Group at any time without prior notice.

SCHEME Electrical		
DATE 19.10.2023.	REV.	PAGE 2 / 3

SCHEME NAME
EN_011-PCM4.CO.S_HCD-I_BUF.4_1D



Legend	
Hydraulic	
	Hot water
	Cold water
	DHW hot water
	DHW cold water
	DHW mixed water
	DHW recirculaiton water
	Refrigerant fluid
	Gas connection
	Electric connection
Electric	
	BN Brown (L1)
	BU Blue (N)
	YG yellow green (PE)
	BK black (L2)
	GY Grey (L3)
	RD red
	Dry contact
	BUS connection
	Generic signal
	Sensor signal

- This schematic is for example only and does not replace design by a qualified technician;
- The final schematic must be prepared respecting all the laws, norms and decrees in force, in order to facilitate a correct installation in compliance with the rule of the art;
- For the proper functioning of all system components, follow the instructions in the design, installation and user manuals provided by the manufacturer;
- This outline may be amended by the Ariston Group at any time without prior notice.

SCHEME			SCHEME NAME
Legend			EN_011-PCM4.CO.S_HCD-I_BUF.4_1D
DATE	REV.	PAGE	
19.10.2023.		3 / 3	