

Pos.	Description
	KIT ZONE MANAGER H-C
	WIRED ROOM THERMOSTAT
	MGM III H
	MGM II H
	MOTORIZED 3-WAY VALVE
	EXPANSION VESSEL - DHW
	HEATING-DHW 3-WAY VALVE
	CIRCULATOR GENERIC
1	EXTERNAL UNIT HHP - MONOBLOC 1 -PH OR 3-PH
2	IDU FS MONO
3	SYSTEM INTERFACE
4	LIGHT GATEWAY
5	EXTERNAL PROBE
6	KIT ANTI-FREEZE
7	BUFFER TANK 4 ATTACKS WITH T PROBE
10	DHW INLET SAFETY GROUP
11	HE KIT BELOW ODU
12	THERMOSTATIC MIXING VALVE
12	UNDER FLOOR HEATING-COOLING
13	FANCOIL HEATING-COOLING
14	BY-PASS VALVE

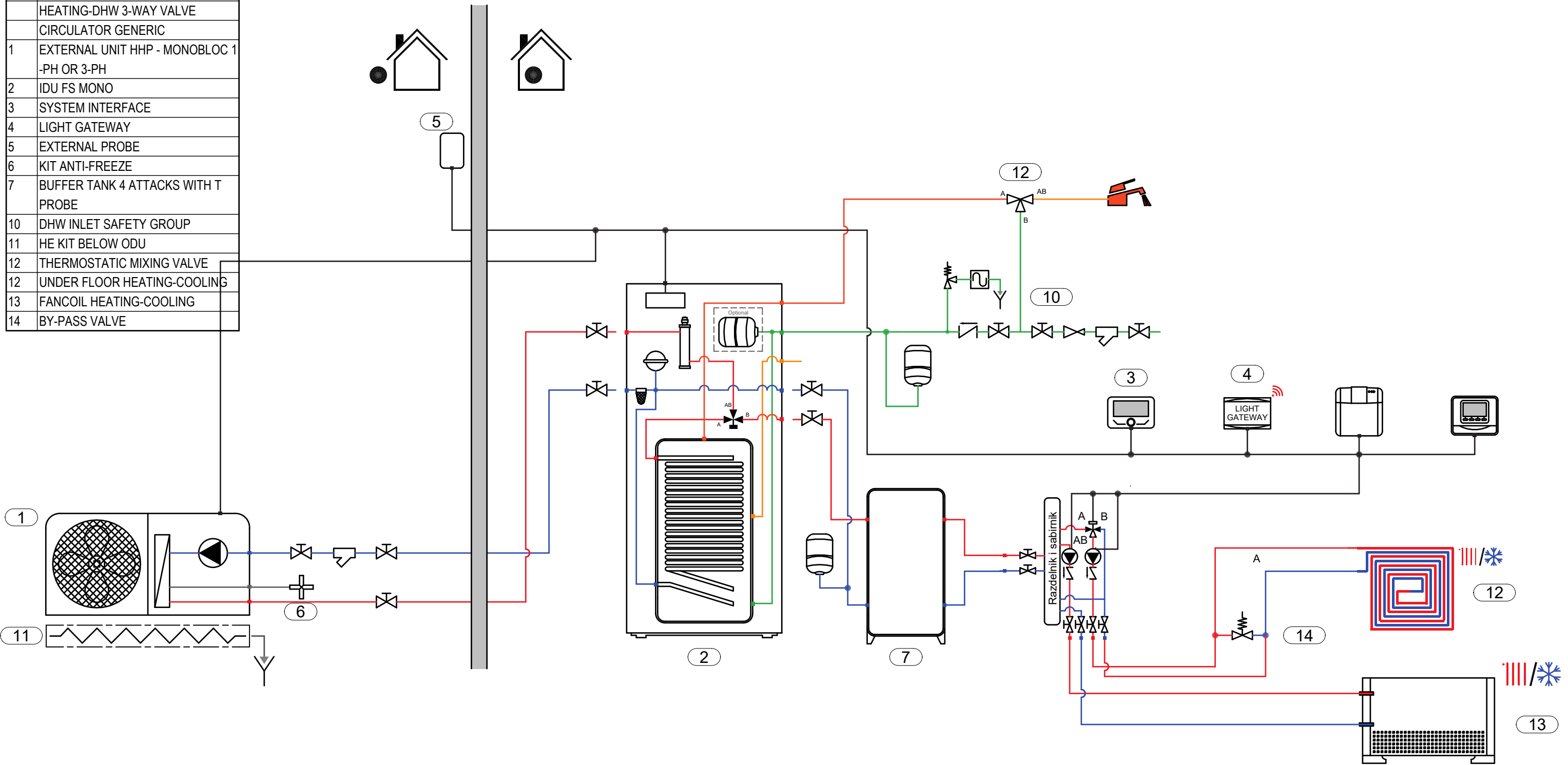

- This schematic is for example only and does not replace design by a qualified technician;
- The final schematic must be prepared respecting all the laws, norms and decrees in force, in order to facilitate a correct installation in compliance with the rule of the art;
- For the proper functioning of all system components, follow the instructions in the design, installation and user manuals provided by the manufacturer;
- This outline may be amended by the Ariston Group at any time without prior notice.

SCHEME		
Hydraulic		
DATE	REV.	PAGE
19.10.2023.		1 / 3

SCHEME NAME  
EN\_010-PCM4.CO.M\_HCD-I\_BUF.4\_1D

Pos.	Description
	KIT ZONE MANAGER H-C
	WIRED ROOM THERMOSTAT
	MGM III H
	MGM II H
	MOTORIZED 3-WAY VALVE
	EXPANSION VESSEL - DHW
	HEATING-DHW 3-WAY VALVE
	CIRCULATOR GENERIC
1	EXTERNAL UNIT HHP - MONOBLOC 1 -PH OR 3-PH
2	IDU FS MONO
3	SYSTEM INTERFACE
4	LIGHT GATEWAY
5	EXTERNAL PROBE
6	KIT ANTI-FREEZE
7	BUFFER TANK 4 ATTACKS WITH T PROBE
10	DHW INLET SAFETY GROUP
11	HE KIT BELOW ODU
12	THERMOSTATIC MIXING VALVE
12	UNDER FLOOR HEATING-COOLING
13	FANCOIL HEATING-COOLING
14	BY-PASS VALVE

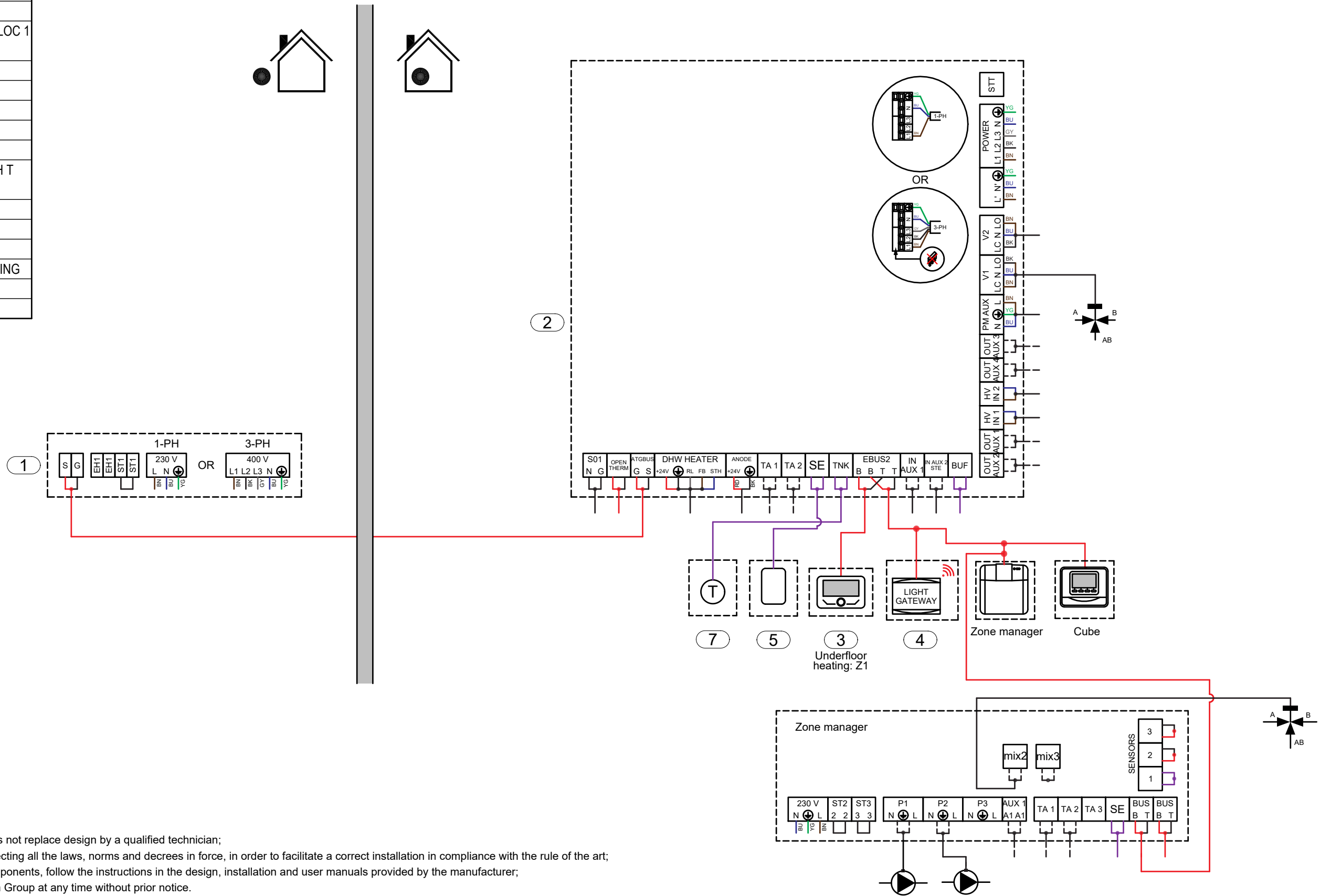















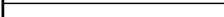
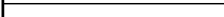

- This schematic is for example only and does not replace design by a qualified technician;
- The final schematic must be prepared respecting all the laws, norms and decrees in force, in order to facilitate a correct installation in compliance with the rule of the art;
- For the proper functioning of all system components, follow the instructions in the design, installation and user manuals provided by the manufacturer;
- This outline may be amended by the Ariston Group at any time without prior notice.

SCHEME		
Electrical		
DATE	REV.	PAGE
19.10.2023.		2 / 3

SCHEME NAME  
**EN\_010-PCM4.CO.M\_HCD-I\_BUF.4\_1D**



<b>Legend</b>	
<b>Hydraulic</b>	
	Hot water
	Cold water
	DHW hot water
	DHW cold water
	DHW mixed water
	DHW recirculaiton water
	Refrigerant fluid
	Gas connection
	Electric connection
<b>Electric</b>	
	BN Brown (L1)
	BU Blue (N)
	YG yellow green (PE)
	BK black (L2)
	GY Grey (L3)
	RD red
	Dry contact
	BUS connection
	Generic signal
	Sensor signal

- This schematic is for example only and does not replace design by a qualified technician;
- The final schematic must be prepared respecting all the laws, norms and decrees in force, in order to facilitate a correct installation in compliance with the rule of the art;
- For the proper functioning of all system components, follow the instructions in the design, installation and user manuals provided by the manufacturer;
- This outline may be amended by the Ariston Group at any time without prior notice.

SCHEME			SCHEME NAME
Legend			EN_010-PCM4.CO.M_HCD-I_BUF.4_1D
DATE	REV.	PAGE	
19.10.2023.		3 / 3	